

Module 4 initiation aux relevés topographiques

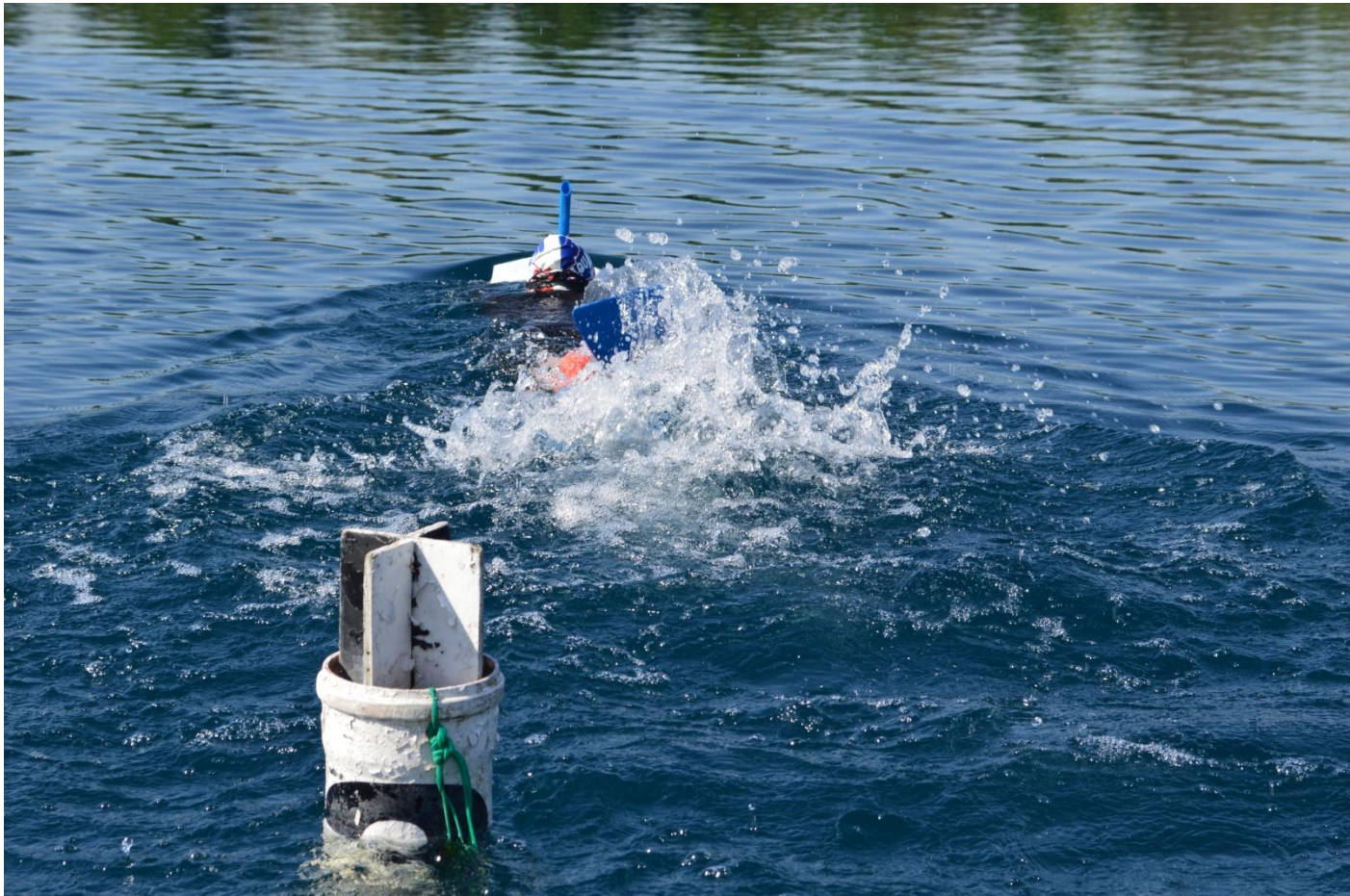

Avant de parler de relevés topographiques nous allons voir les différentes façons de mettre un parcours en place

1. La mise en place avec une planchette

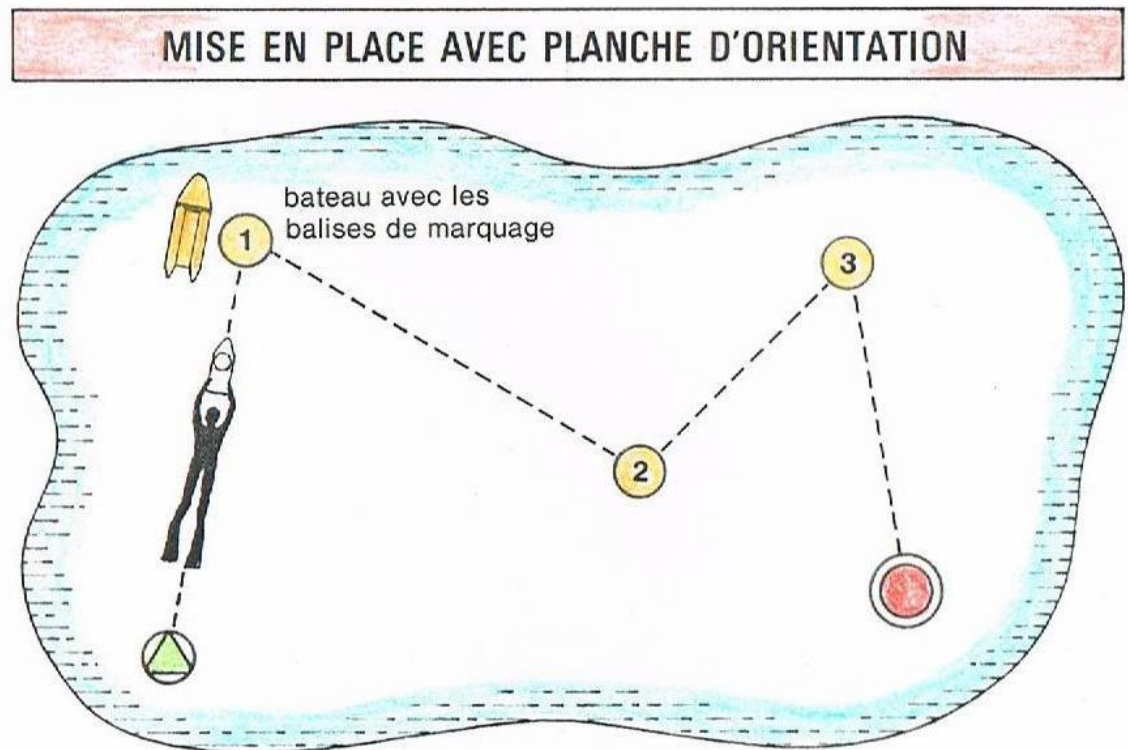

2. Mise en place par triangulation

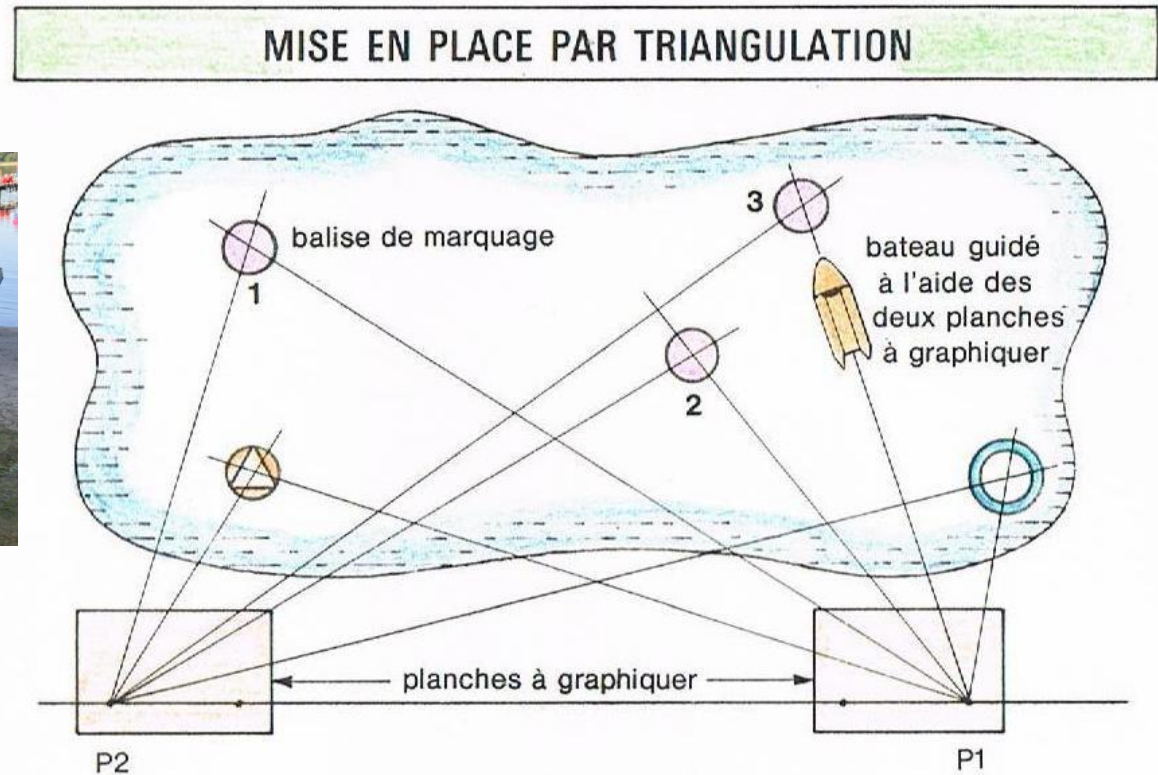

3. Mise en place avec une visée laser

Bushnell en fabrique vous pouvez trouver des jumelles laser à partir de 262€

<http://www.topographie-laser.eu/telemetre-et-mesure/telemetres/jumelles-laser.html>

Ceci est un exemple il doit y avoir d'autres revendeurs



Principe du relevé topographique

1. Le matériel

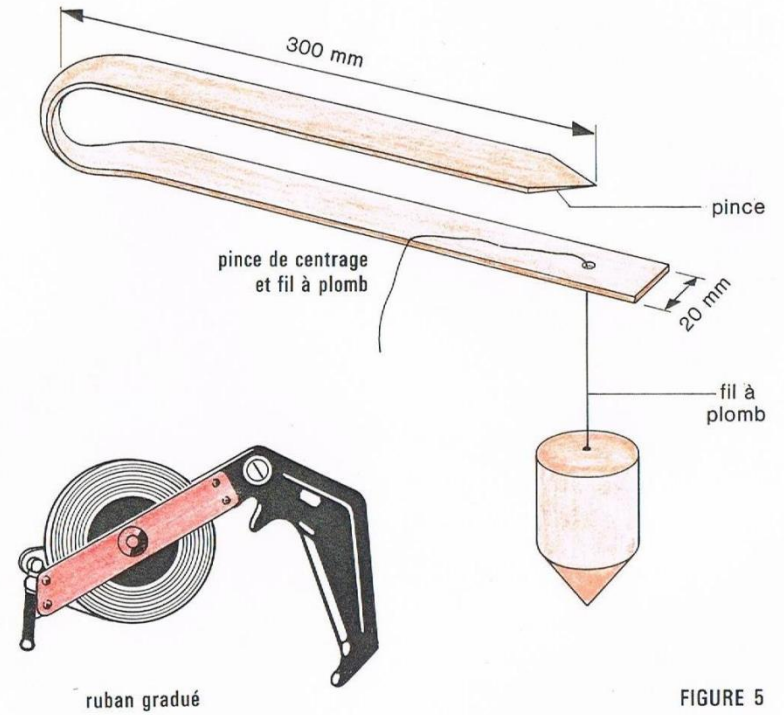
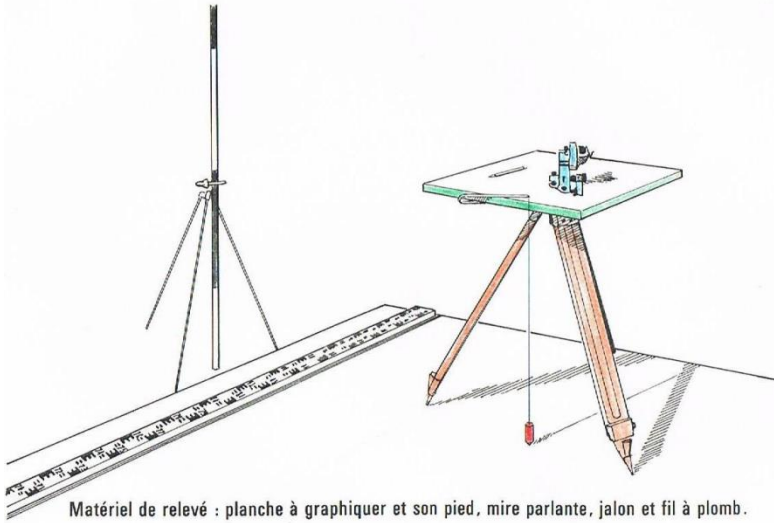

FIGURE 5



Matériel de relevé : planche à graphier et son pied, mire parlante, jalon et fil à plomb.



2. Le principe du relevé

FIGURE 4 . LEVÉ PAR INTERSECTION

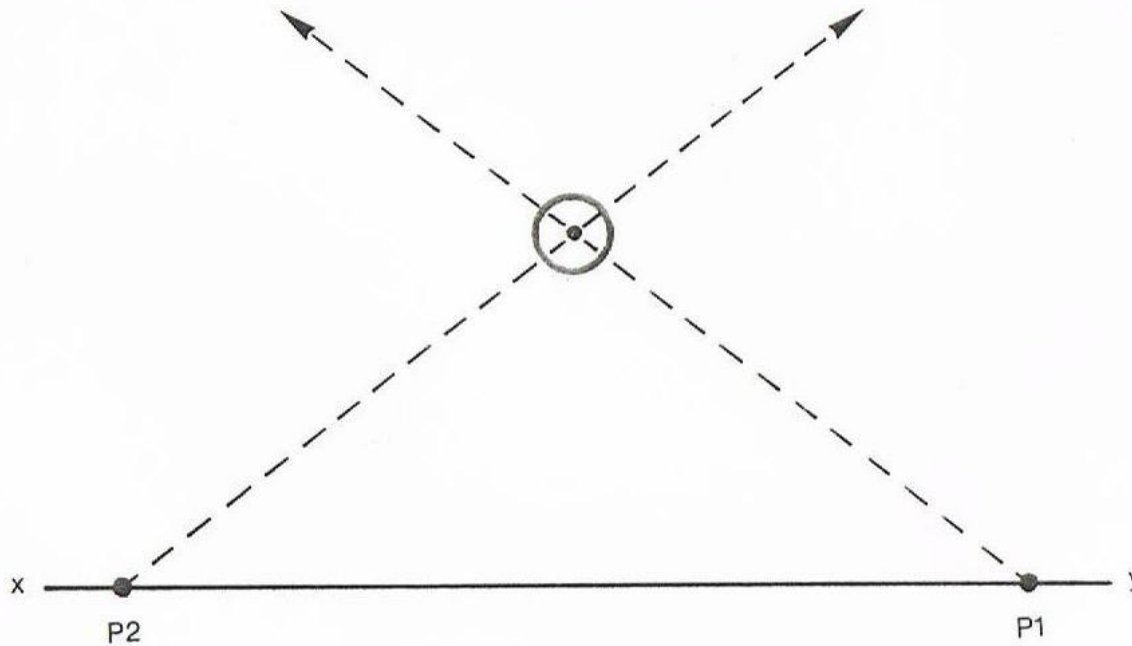

2.1 relevés en P1

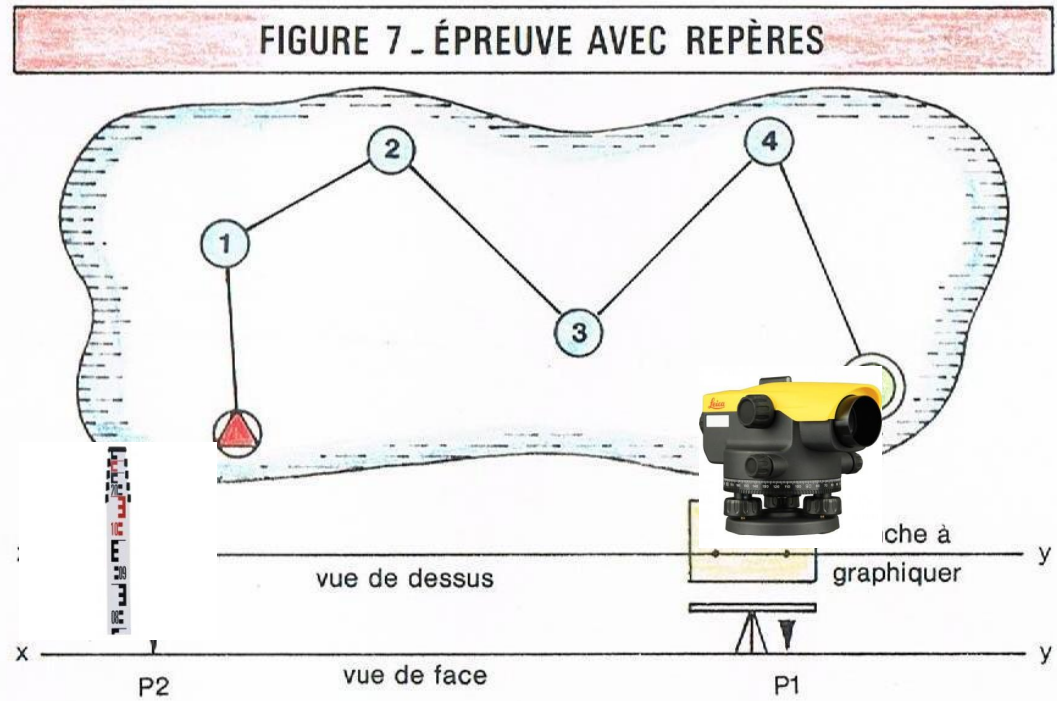

2.1 relevés en P1

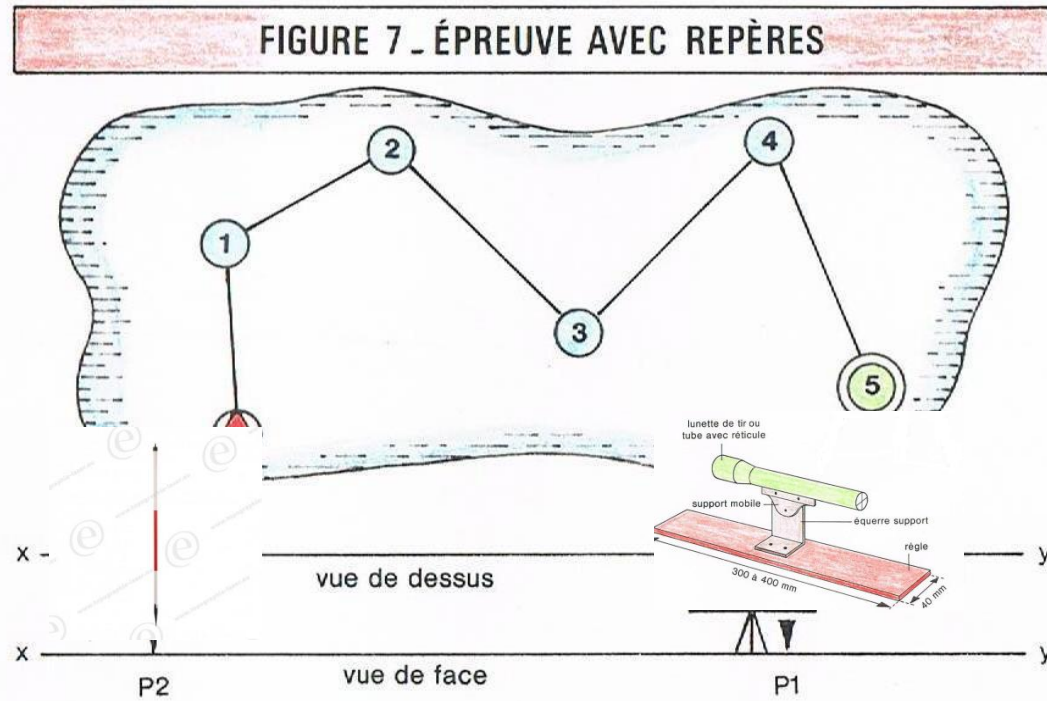

2.1 relevés en P1

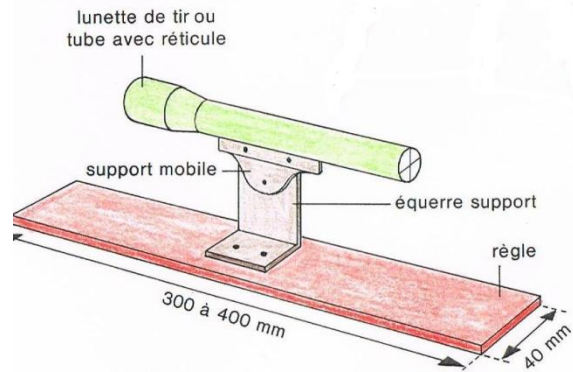
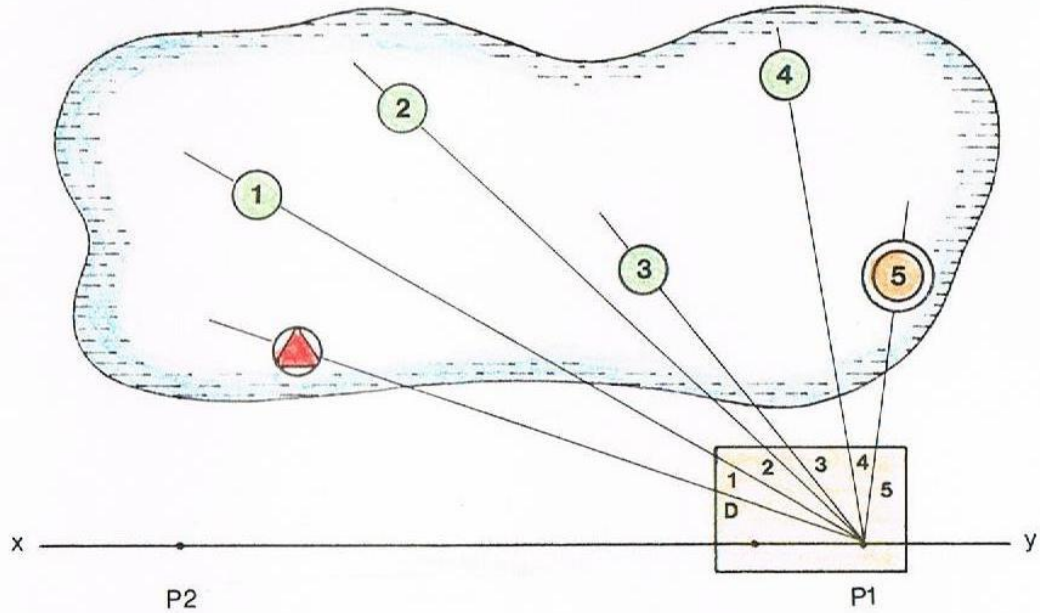

FIGURE 8 _ ÉPREUVE AVEC REPÈRES





Avez vous des questions?

S.ZAEPFEL